

FILTRI

- Parti filtranti facilmente estraibili.
- Produzione standard: cartucce filtranti in lamiera con fori da 1 mm. A richiesta, disponibili con fori da 0,5 mm, 2 mm o 3 mm ed eventuale copertura con rete metallica da 80 a 500 mesh.
- Finitura standard: lucidatura esterna e satinatura interna grana 120. Altre finiture a richiesta.
- Max. pressione di esercizio: 5 bar.

FILTERS

- Filtering parts easily extractable.
- Standard production: sheet metal filter cartridges with 1 mm holes. On request available with 0.5 mm, 2 mm or 3 mm holes and metal screen cover from 80 to 500 meshes.
- Standard finish: 120 grain external polishing and internal glazing. Other finishes on request.
- Maximum operating pressure: 5 bars.

FILTRES

- Parties filtrantes facilement extractibles.
- Production standard: cartouches filtrantes en tôle avec trous de 1 mm. Sur demande, disponibles avec des trous de 0,5 mm, 2 mm ou 3 mm et éventuelle couverture avec une grille métallique de 80 à 500 mesh.
- Finissage standard: polissage extérieur et satinage intérieur grain 120. Autres finissages sur demande.
- Pression d'exploitation maximum: 5 bars.

FILTROS

- Las piezas filtrantes se pueden extraer fácilmente.
- Producción estándar: cartuchos filtrantes de chapa con orificios de 1 mm. A pedido, se pueden suministrar con orificios de 0,5 mm, 2 mm o 3 mm y, eventualmente, con cobertura de red metálica de 80 a 500 mesh.
- Acabado estándar: pulido exterior y satinado interior grano 120. A pedido, se pueden suministrar otros acabados.
- Máxima presión de ejercicio: 5 bares.

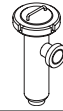
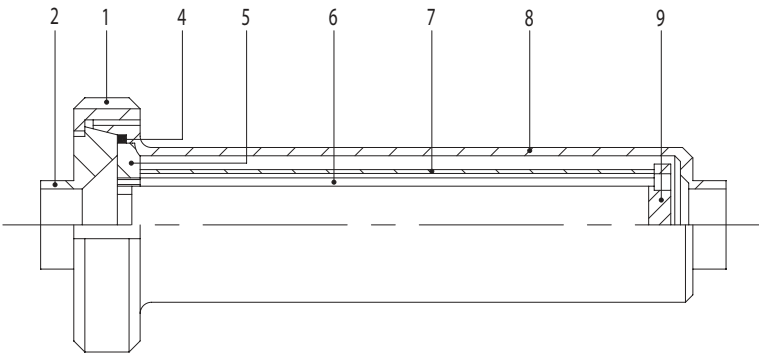
**FILTRO LINEA
LINE FILTER**
**FILTRE DROIT
FILTRO LÍNEA**

- | | |
|--|--|
| 1. Girella
Nut
Écrou
Tuerca | 6. Tirante
Tie rod
Tirant
Tirante |
| 2. Riduzione conica
Plain connection
Embout lisse réduit
Casquillo reducido | 7. Rete filtro
Filter
Tamis
Red filtro |
| 4. Guarnizione
Seal
Joint
Junta | 8. Corpo filtro
Filter casing
Corps du filtre
Cuerpo filtro |
| 5. Disco superiore
Upper disk
Disque supérieur
Disco superior | 9. Disco inferiore
Lower disk
Disque inférieur
Disco inferior |

**CODIFICAIONE
CODING
CODIFICATION
CODIFICACIÓN**

Pos.	Cod. base	Norme	1" 25	D 25 28	D 32 34	1 1/2" 38	D 40 40	2" 51	D 50 52	2 1/2" 63	D 65 70	3" 76	D 80 85	4" 101	D 100 101	4" 104	D 100 104	Mat.	Part. o agg.
1	121	D	65	65	65	65	65	65	65	80	80	100	100	100	100	100	100	4L/6L	
2	116	D	65/25	65/28	65/34	65/38	65/40	65/51	65/52	80/63	80/70	100/76	100/85	100/101	100/101	100/104	100/104	4L/6L	
4	131	D	65	65	65	65	65	65	65	80	80	100	100	100	100	100	100	N	
5	400		25/52	25/52	25/52	25/52	25/52	25/52	25/52	63/70	63/70	76/85	76/85	101	101	101	101	6L	05
6	400		25/40	25/40	25/40	25/40	25/40	51/52	51/52	63/70	63/70	76/85	76/85	101	101	101	101	6L	06
7	400		25/52	25/52	25/52	25/52	25/52	25/52	25/52	63/70	63/70	76/85	76/85	101	101	101	101	6L	07
8	400		25/40	25/40	25/40	25/40	25/40	51/52	51/52	63/70	63/70	76/85	76/85	101	101	101	101	4L/6L	08
9	400	L	25	28	34	38	40	51	52	63	70	76	85	101	101	101	101	6L	09

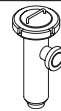
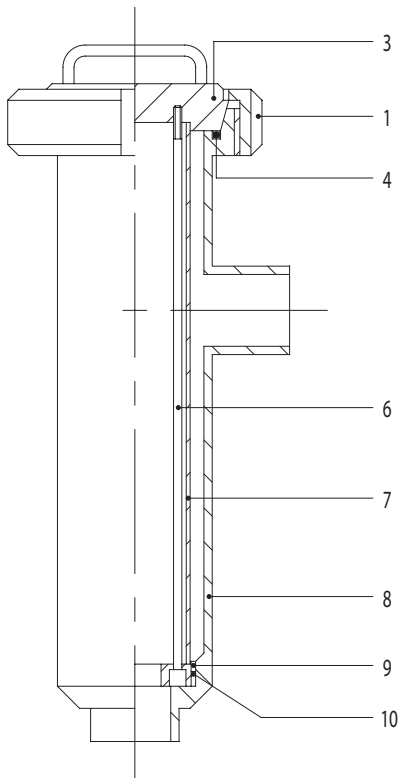
**FILTRO 90°
90° FILTER**
**FILTRE 90°
FILTRO 90°**

- | | |
|--|--|
| <p>1. Girella
Nut
Écrou
Tuerca</p> <p>3. Tappo speciale
Blank
Bouchon à poignée
Tapón especial</p> <p>4. Guarnizione
Seal
Joint
Junta</p> <p>6. Tirante
Tie rod
Tirant
Tirante</p> | <p>7. Rete filtro
Filter
Tamis
Red filtro</p> <p>8. Corpo filtro
Filter casing
Corps du filtre
Cuerpo filtro</p> <p>9. Disco inferiore
Lower disk
Disque inférieur
Disco inferior</p> <p>10. Anello di tenuta OR
OR seal ring
Joint torique
Junta OR</p> |
|--|--|

CODIFICAIONE
CODING
CODIFICATION
CODIFICACIÓN

Pos.	Cod. base	Norme	1" 25	D 25 28	D 32 34	1 1/2" 38	D 40 40	2" 51	D 50 52	2 1/2" 63	D 65 70	3" 76	D 80 85	4" 101	D 100 101	4" 104	D 100 104	Mat.	Part. o agg.
1	121	D	65	65	65	65	65	65	65	80	80	100	100	100	100	100	100	4L/6L	
3	410		65	65	65	65	65	65	65	80	80	100	100	100	100	100	100	4L/6L	03
4	131	D	65	65	65	65	65	65	65	80	80	100	100	100	100	100	100	N	
6	410		25/40	25/40	25/40	25/40	25/40	51/52	51/52	63/70	63/70	76/85	76/85	101	101	101	101	6L	06
7	410		25/52	25/52	25/52	25/52	25/52	25/52	25/52	63/70	63/70	76/85	76/85	101	101	101	101	6L	07
8	410		25/40	25/40	25/40	25/40	25/40	51/52	51/52	63/70	63/70	76/85	76/85	101	101	101	101	4L/6L	08
9	410	L	25	28	34	38	40	51	52	63	70	76	85	101	101	101	101	6L	09
10	OR		159	159	159	159	159	159	159	174	174	4350	4350	3375	3375	3375	3375	N	

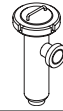

PORTATA M³/H
FLOWRATE M³/H

DÉBIT M³/H
CAUDAL M³/H

Velocità del fluido m/sec Fluid speed m/sec Vitesse du fluide m/sec Velocidad del fluido m/sec	0,50	1,00	1,50	2,00
25,4	0,745	1,494	2,239	2,988
28	0,882	1,764	2,646	3,528
34	1,447	2,894	4,341	5,788
38,1	1,785	3,571	5,356	7,142
40	2,041	4,082	6,123	8,164
50,8	3,294	6,588	9,882	13,176
52	3,531	7,063	10,594	14,126
63,5	5,191	10,382	15,573	20,764
70	6,152	11,336	18,460	24,616
76,2	7,509	15,019	22,528	30,038
85	9,270	18,540	27,810	37,080
101,6	14,130	28,260	42,390	56,520

PERDITE DI CARICO
PRESSURE DROP

PERTES DE CHARGE
PÉRDIDA DE CARGA

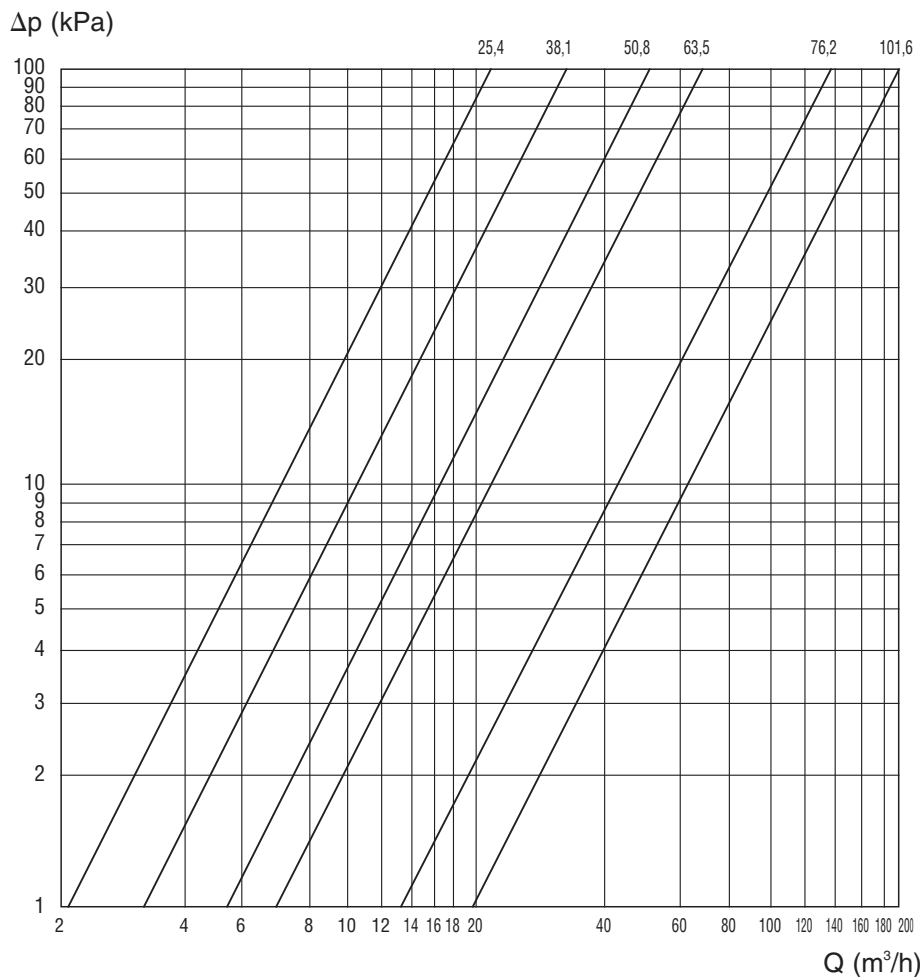

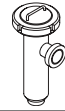

SPECOLE

- Di solida e robusta costruzione.
- Vetro in pyrex. A richiesta, protezione esterna in plexiglas.
- Corredate di speciali tiranti e guarnizioni per eliminare le pressioni di carico e le vibrazioni sul vetro.
- Finitura standard: lucidatura esterna e satinatura interna grana 120. Altre finiture a richiesta.
- Max. pressione di esercizio: 10 bar.

SIGHT GLASSES

- High strength construction.
- Pyrex glass. On request plexiglas external guard.
- Equipped with special tie rods and seals to prevent load pressures and vibrations on the glass.
- Standard finish: 120 grain external polishing and internal glazing. Other finishes on request.
- Maximum operating pressure: 10 bars.

REGARDS

- Fabrication solide et robuste.
- Verre en pyrex. Sur demande, protection externe en plexiglas.
- Munis de tirants spéciaux et de joints pour éliminer les pressions de charge et les vibrations sur le verre.
- Finissage standard: polissage extérieur et satinage intérieur grain 120. Autres finissages sur demande.
- Pression d'exploitation maximum: 10 bars.

MIRILLAS

- Fabricación sólida y robusta.
- Vidrio pyrex. A pedido, protección exterior de plexiglás.
- Equipadas con tirantes especiales y con juntas para eliminar las presiones de carga y las vibraciones sobre el vidrio.
- Acabado estándar: pulido exterior y satinado interior grano 120. A pedido, se pueden suministrar otros acabados.
- Máxima presión de ejercicio: 10 bares.

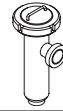

**SPECOLA
SIGHT GLASS**

**REGARD
MIRILLA**

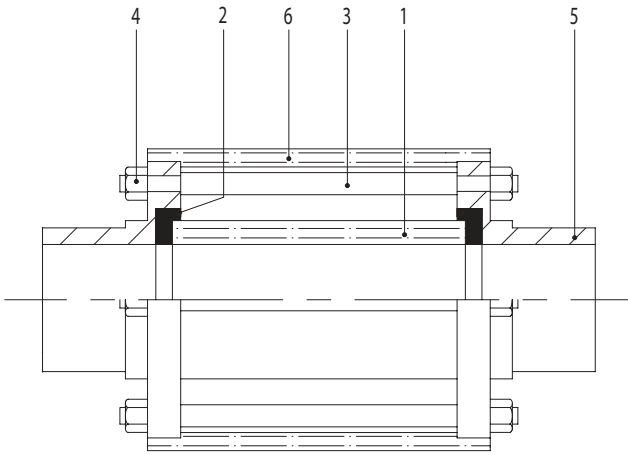

- | | |
|--|---|
| 1. Tubo pyrex
Pyrex pipe
Tube pyrex
Pyrex | 4. Dado autobloccante
Self-locking nut
Écrou de sûreté
Tuerca de seguridad |
| 2. Guarnizione
Seal
Joint
Junta | 5. Flangia
Flange
Bride
Brida |
| 3. Tirante
Tie rod
Tirant
Tirante | 6. Protezione
Guard
Protection
Protección |

CODIFICAIONE
CODING
CODIFICATION
CODIFICACIÓN

Pos.	Cod. base	Norme	1" 25	D 25 28	D 32 34	1 1/2" 38	D 40 40	2" 51	D 50 52	2 1/2" 63	D 65 70	3" 76	D 80 85	4" 101	D 100 101	4" 104	D 100 104	Mat.	Part. o agg.
1	450		25	28	34	38	40	51	52	63	70	76	85	101	101	104	104	P	01
2	450		25	28	34	38/40	38/40	51/52	51/52	63	70	76	85	101	101	104	104	S/E/V/T	02
3	450		25/104	25/104	25/104	25/104	25/104	25/104	25/104	25/104	25/104	25/104	25/104	25/104	25/104	25/104	25/104	4L	03
4	450		25/104	25/104	25/104	25/104	25/104	25/104	25/104	25/104	25/104	25/104	25/104	25/104	25/104	25/104	25/104	4L	04
5	450	L	25	28	34	38	40	51	52	63	70	76	85	101	101	104	104	4L/6L	05
6	450		25	28	34	38/40	38/40	51/52	51/52	63	70	76	85	101/104	101/104	101/104	101/104	PG	06



FILTRO LINEA EL.
LINE FILTER PE.
FILTRE DROIT BL.
FILTRO LÍNEA EL.

400 L

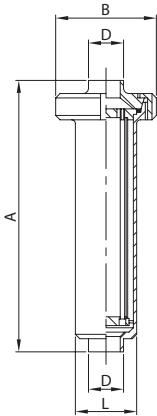

DN	A	B	D	L	gr
28	320,0	112,0	28,0	70,0	3.000
34	320,0	112,0	34,0	70,0	3.000
40	320,0	112,0	40,0	70,0	3.000
52	420,0	112,0	52,0	70,0	3.300
70	516,0	127,0	70,0	85,0	4.650
85	575,0	148,0	85,0	102,0	5.700
101	700,0	148,0	101,6	129,0	7.000
104	700,0	148,0	104,0	129,0	7.000

FILTRO LINEA EF./BC. MR.
LINE FILTER ME./TP. EG.
FILTRE DROIT BF./PC. DR.
FILTRO LÍNEA ER./C. MR.

401 D

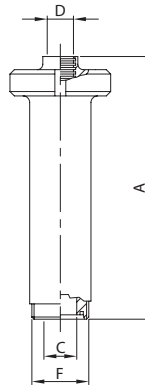

DN	A	C	D	F	gr
25	320,0	25,0	28,0	52-6	3.130
32	320,0	31,0	34,0	58-6	3.170
40	320,0	37,0	40,0	65-6	3.210
50	420,0	49,0	52,0	78-6	3.580
65	521,0	66,0	70,0	95-6	5.030
80	584,0	81,0	85,0	110-4	6.300
100	690,0	97,6	101,6	130-4	8.000
104	690,0	100,0	104,0	130-4	8.000

FILTRO 90° EL.
90° FILTER PE.
FILTRE 90° BL.
FILTRO 90° EL.

410 L

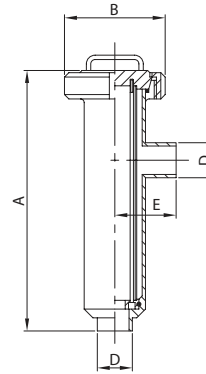

DN	A	B	D	E	gr
28	306,0	112,0	28,0	70,0	3.100
34	306,0	112,0	34,0	70,0	3.100
40	306,0	112,0	40,0	70,0	3.100
52	406,0	112,0	52,0	72,0	3.400
70	503,0	127,0	70,0	85,0	4.800
85	561,0	148,0	85,0	96,0	5.900
101	662,0	148,0	101,6	117,0	7.200
104	662,0	148,0	104,0	117,0	7.200

FILTRO 90° EF./EL.
90° FILTER ME./PE.
FILTRE 90° BF./BL.
FILTRO 90° ER./EL.

411 D

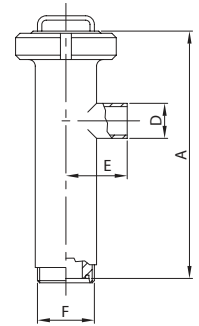

DN	A	D	E	F	gr
25	300,0	28,0	70,0	52-6	3.230
32	300,0	34,0	70,0	58-6	3.270
40	300,0	40,0	70,0	65-6	3.310
50	398,0	52,0	72,0	78-6	3.680
65	495,0	70,0	85,0	95-6	5.180
80	553,0	85,0	96,0	110-4	6.700
100	642,0	101,6	117,0	130-4	8.200
104	642,0	104,0	117,0	130-4	8.200

FILTRO 90° EF./EF.
90° FILTER ME./ME.
FILTRE 90° BF./BF.
FILTRO 90° ER./ER.

412 D

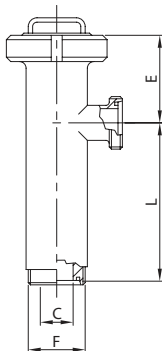

DN	C	E	F	L	gr
25	25,0	100,0	52-6	200,0	3.360
32	31,0	100,0	58-6	200,0	3.440
40	37,0	100,0	65-6	200,0	3.520
50	49,0	115,0	78-6	283,0	3.960
65	66,0	117,0	95-6	378,0	5.560
80	81,0	131,0	110-4	422,0	7.100
100	97,6	120,0	130-4	522,0	9.200
104	100,0	120,0	130-4	522,0	9.200

RIVESTIMENTO MESH
MESH COVERING
MESH GRILLE
REVESTIMIENTO MESH

400 612



DN	MESH
25/40	100/200 300 400 500
51/52	100/200 300 400 500
63/70	100/200 300 400 500
76/85	100/200 300 400 500
101/104	100/200 300 400 500

CARTUCCIA FILTRO LINEA
LINE FILTER CARTRIDGE
TAMIS FILTRE DROIT
CARTUCHO FILTRO LÍNEA

400 410

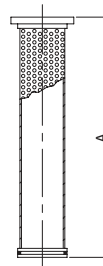

DN	A
25/40	271,0
51/52	371,0
63/70	466,0
76/85	516,0
101/104	621,0

CARTUCCIA FILTRO 90°
90° FILTER CARTRIDGE
TAMIS FILTRE 90°
CARTUCHO FILTRO 90°

410 410

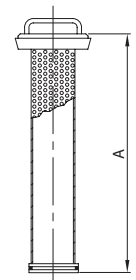

DN	A
25/40	278,0
51/52	378,0
63/70	473,0
76/85	527,0
101/104	636,0

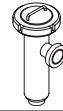

**SPECOLA EL.
SIGHT GLASS PE.
REGARD BL.
MIRILLA EL.**

450 L

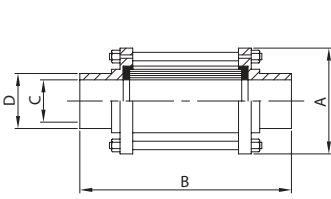

**SPECOLA EF/EF.
SIGHT GLASS ME./ME.
REGARD BF/BF.
MIRILLA ER./ER.**

452 D

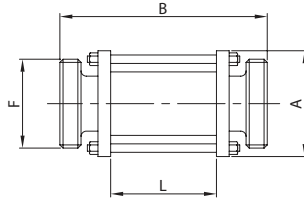

**SPECOLA BC. G./EF. MT.
SIGHT GLASS TP. N./ME. ED.
REGARD PC. E./BF. DN.
MIRILLA C. T./ER. MD.**

454 D

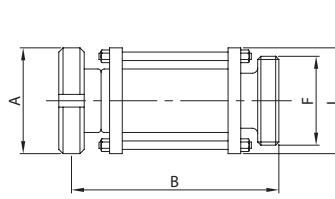

**SPECOLA EL. + V. F. EL.
SIGHT GLASS PE. + B. V. PE.
REGARD BL. + V. P. BL.
MIRILLA EL. + V. M. EL.**

460 L

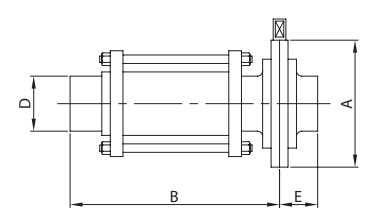

DN	A	B	C	D	gr
28	60,0	143,0	25,0	28,0	400
34	65,0	149,0	31,0	34,0	500
40	70,0	153,0	37,0	40,0	680
52	85,0	157,0	49,0	52,0	860
70	100,0	163,0	66,0	70,0	1.090
85	115,0	169,0	81,0	85,0	1.280
101	140,0	173,0	97,6	101,6	2.760
104	140,0	173,0	100,0	104,0	2.760

DN	A	B	F	L	gr
25	60,0	157,0	52-6	83,0	610
32	65,0	157,0	58-6	83,0	700
40	70,0	157,0	65-6	83,0	920
50	85,0	157,0	78-6	83,0	1.230
65	100,0	161,0	95-6	83,0	1.520
80	115,0	171,0	110-4	83,0	1.770
100	140,0	171,0	130-4	83,0	3.370
104	140,0	171,0	130-4	83,0	3.370

DN	A	B	F	L	gr
25	63,0	157,0	52-6	60,0	750
32	70,0	160,0	58-6	65,0	900
40	78,0	161,0	65-6	70,0	1.180
50	92,0	163,0	78-6	85,0	1.600
65	112,0	169,0	95-6	100,0	2.200
80	127,0	179,0	110-4	115,0	2.630
100	148,0	181,0	130-4	140,0	4.790
104	148,0	181,0	130-4	140,0	4.790

DN	A	B	D	E	gr
28	79,0	151,0	28,0	34,0	760
34	85,0	154,0	34,0	38,0	900
40	92,0	156,0	40,0	38,0	1.180
52	105,0	158,0	52,0	40,0	1.500
70	125,0	162,0	70,0	41,0	1.970
85	137,0	165,0	85,0	42,0	2.430
101	157,0	167,0	101,6	44,0	4.180
104	157,0	167,0	104,0	44,0	4.180

**SPECOLA EF. + V. F. EF.
SIGHT GLASS ME. + B. V. ME.
REGARD BF. + V. P. BF.
MIRILLA ER. + V. M. ER.**

462 D

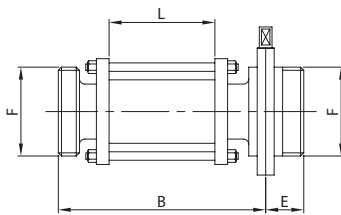

**SPECOLA PIANA ES.
SIGHT GLASS WE.
INDIC. DE CIRC. PLAT BS.
MIRILLA PLANA ES.**

441 D

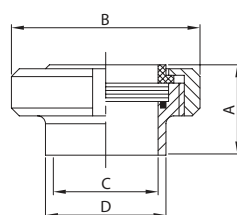

**SPECOLA PIANA EM.
SIGHT GLASS EE.
INDIC. DE CIRC. PLAT BD.
MIRILLA PLANA EM.**

442 D

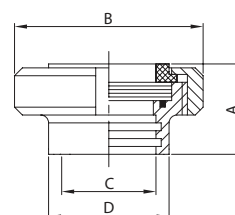

DN	B	E	F	L	gr
25	158,0	34,0	52-6	83,0	1.090
32	158,0	34,0	58-6	83,0	1.310
40	158,0	38,0	65-6	83,0	1.650
50	158,0	38,0	78-6	83,0	2.170
65	161,0	38,0	95-6	83,0	2.650
80	166,0	41,5	110-4	83,0	3.370
100	166,0	44,0	130-4	83,0	5.330
104	166,0	44,0	130-4	83,0	5.330

DN	A	B	C	D	gr
25	35,0	63,0	25,0	28,0	350
32	38,0	70,0	31,0	34,0	420
40	39,0	78,0	37,0	40,0	530
50	42,0	92,0	49,0	52,0	730
65	47,0	112,0	66,0	70,0	1.110
80	52,0	127,0	81,0	85,0	1.590
100	62,0	148,0	97,6	101,6	2.380
104	62,0	148,0	100,0	104,0	2.380

DN	A	B	C	D	gr
25	35,0	63,0	28,0	35,0	350
32	38,0	70,0	34,0	41,0	420
40	39,0	78,0	40,0	48,0	530
50	42,0	92,0	52,0	61,0	730
65	47,0	112,0	70,0	79,0	1.110
80	52,0	127,0	85,0	93,0	1.590
100	62,0	148,0	101,6	114,0	2.380
104	62,0	148,0	104,0	114,0	2.380



FILTRO LINEA EL.
LINE FILTER PE.
FILTRE DROIT BL.
FILTRO LÍNEA EL.

400 L

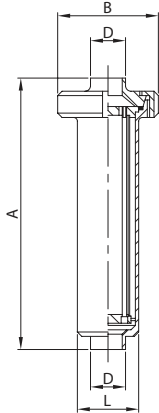

DN	A	B	D	L	gr
25	320,0	112,0	25,4	70,0	3.000
38	320,0	112,0	38,1	70,0	3.000
51	420,0	112,0	50,8	70,0	3.300
63	516,0	127,0	63,5	85,0	4.650
76	574,0	148,0	76,2	102,0	5.700
101	700,0	148,0	101,6	129,0	7.000

FILTRO LINEA EF./BL. MR.
LINE FILTER ME./L. EG.
FILTRE DROIT BF./PL. DR.
FILTRO LÍNEA ER./C. MR.

401 S

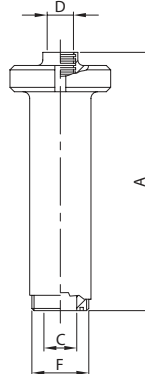

DN	A	C	D	F	gr
25	327,0	22,4	25,4	40-6	3.070
38	327,0	35,1	38,1	60-6	3.200
51	427,0	47,8	50,8	70-6	3.525
63	529,0	60,5	63,5	85-6	5.040
76	594,0	72,9	76,2	98-6	6.200
101	700,0	97,6	101,6	132-6	8.140

FILTRO 90° EL.
90° FILTER PE.
FILTRE 90° BL.
FILTRO 90° EL.

410 L

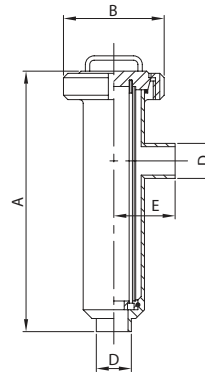

DN	A	B	D	E	gr
25	307,0	112,0	25,4	70,0	3.100
38	307,0	112,0	38,1	70,0	3.100
51	407,0	112,0	50,8	82,0	3.400
63	503,0	127,0	63,5	85,0	4.800
76	561,0	148,0	76,2	96,0	5.900
101	662,0	148,0	101,6	117,0	7.200

FILTRO 90° EF./EL.
90° FILTER ME./PE.
FILTRE 90° BF./BL.
FILTRO 90° ER./EL.

411 S

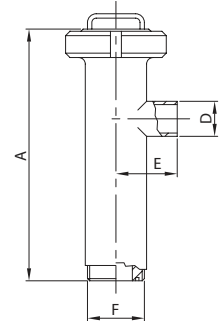

DN	A	D	E	F	gr
25	306,0	25,4	70,0	40-6	3.170
38	306,0	38,1	70,0	60-6	3.300
51	405,0	50,8	72,0	70-6	3.620
63	503,0	63,5	85,0	85-6	5.190
76	561,0	76,2	96,0	98-6	6.400
101	652,0	101,6	117,0	132-6	8.340

FILTRO 90° EF./EF.
90° FILTER ME./ME.
FILTRE 90° BF./BF.
FILTRO 90° ER./ER.

412 S

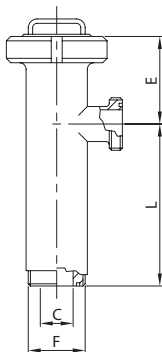

DN	C	E	F	L	gr
25	22,4	99,0	40-6	207,0	3.240
38	35,1	99,0	60-6	207,0	3.500
51	47,8	115,0	70-6	290,0	3.850
63	60,5	117,0	85-6	386,0	5.580
76	72,9	131,0	98-6	430,0	6.900
101	97,6	120,0	132-6	532,0	9.480

RIVESTIMENTO MESH
MESH COVERING
MESH GRILLE
REVESTIMIENTO MESH

400 612



DN	MESH
25/40	100/200 300 400 500
51/52	100/200 300 400 500
63/70	100/200 300 400 500
76/85	100/200 300 400 500
101	100/200 300 400 500

CARTUCCIA FILTRO LINEA
LINE FILTER CARTRIDGE
TAMIS FILTRE DROIT
CARTUCHO FILTRO LÍNEA

400 410

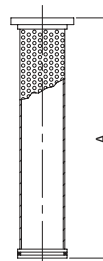

DN	A
25/40	271,0
51/52	371,0
63/70	466,0
76/85	516,0
101	621,0

CARTUCCIA FILTRO 90°
90° FILTER CARTRIDGE
TAMIS FILTRE 90°
CARTUCHO FILTRO 90°

410 410

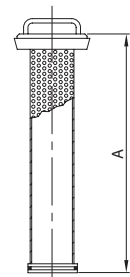

DN	A
25/40	278,0
51/52	378,0
63/70	473,0
76/85	527,0
101	636,0

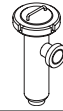

**SPECOLA EL.
SIGHT GLASS PE.
REGARD BL.
MIRILLA EL.**

**SPECOLA EF/EF.
SIGHT GLASS ME./ME.
REGARD BF/BF.
MIRILLA ER./ER.**

**SPECOLA BL. G./EF. MT.
SIGHT GLASS L. N./ME. ED.
REGARD PL. E./BF. DN.
MIRILLA C. T./ER. MD.**

**SPECOLA EL. + V. F. EL.
SIGHT GLASS PE. + B. V. PE.
REGARD BL. + V. P. BL.
MIRILLA EL. + V. M. EL.**

450 L

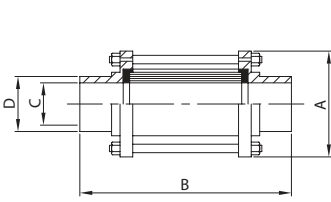

452 S

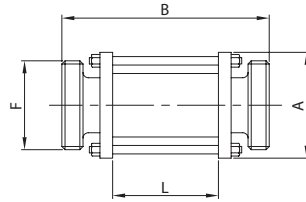

454 S

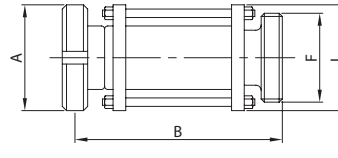

460 L

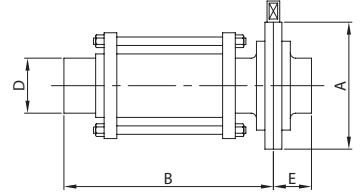

DN	A	B	C	D	gr
25	55,0	147,0	22,4	25,4	400
38	70,0	153,0	35,1	38,1	620
51	85,0	153,0	47,8	50,8	860
63	95,0	163,0	60,5	63,5	950
76	105,0	173,0	72,9	76,2	1.100
101	140,0	173,0	97,6	101,6	2.760

DN	A	B	F	L	gr
25	55,0	165,0	40-6	83,0	550
38	70,0	165,0	60-6	83,0	940
51	85,0	165,0	70-6	83,0	1.270
63	95,0	165,0	85-6	83,0	1.400
76	105,0	165,0	98-6	83,0	1.710
101	140,0	183,0	132-6	83,0	3.760

DN	A	B	F	L	gr
25	51,0	156,0	40-6	55,0	630
38	74,0	159,0	60-6	70,0	1.170
51	84,0	159,0	70-6	85,0	1.500
63	100,0	164,0	85-6	95,0	1.840
76	114,0	169,0	98-6	105,0	2.360
101	150,0	178,0	132-6	140,0	4.980

DN	A	B	D	E	gr
25	79,0	153,0	25,4	34,0	760
38	85,0	156,0	38,1	38,0	1.020
51	105,0	156,0	50,8	40,0	1.500
63	112,0	162,0	63,5	40,0	1.680
76	125,0	167,0	76,2	41,0	1.980
101	157,0	167,0	101,6	44,0	4.180

**SPECOLA EF. + V. F. EF.
SIGHT GLASS ME. + B. V. ME.
REGARD BF. + V. P. BF.
MIRILLA ER. + V. M. ER.**

**SPECOLA PIANA ES.
SIGHT GLASS WE.
INDIC. DE CIRC. PLAT BS.
MIRILLA PIANA ES.**

**SPECOLA PIANA EM.
SIGHT GLASS EE.
INDIC. DE CIRC. PLAT BD.
MIRILLA PIANA EM.**

462 S

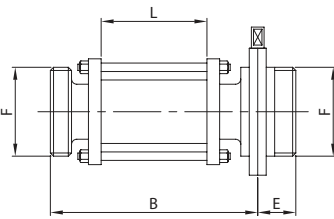

441 S

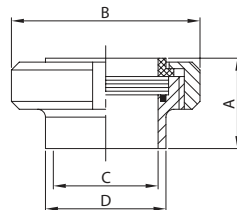

442 S

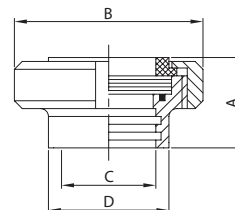

DN	B	E	F	L	gr
25	162,0	34,0	40-6	83,0	990
38	162,0	38,0	60-6	83,0	1.620
51	162,0	40,0	70-6	83,0	2.120
63	163,0	40,0	85-6	83,0	2.450
76	163,0	41,0	98-6	83,0	3.090
101	172,0	44,0	132-6	83,0	5.730

DN	A	B	C	D	gr
25	29,0	51,0	22,4	25,4	220
38	33,0	74,0	35,1	38,1	500
51	36,0	84,0	47,8	50,8	540
63	41,0	100,0	60,5	63,5	990
76	48,0	114,0	72,9	76,2	1.250
101	40,0	150,0	97,6	101,6	2.030

DN	A	B	C	D	gr
25	29,0	51,0	25,4	32,0	220
38	33,0	74,0	38,1	48,0	500
51	36,0	84,0	50,8	61,0	540
63	41,0	100,0	63,5	73,5	990
76	48,0	114,0	76,2	86,0	1.250
101	40,0	154,0	101,6	116,0	2.030



FILTRO LINEA EL.
LINE FILTER PE.
FILTRE DROIT BL.
FILTRO LÍNEA EL.

400 L

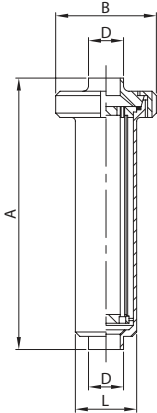

DN	A	B	D	L	gr
25	320,0	112,0	25,4	70,0	3.000
38	320,0	112,0	38,1	70,0	3.000
51	420,0	112,0	50,8	70,0	3.300
63	516,0	127,0	63,5	85,0	4.650
76	574,0	148,0	76,2	102,0	5.700
101	700,0	148,0	101,6	129,0	7.000

FILTRO LINEA EF./BL. MR.
LINE FILTER ME./L. EG.
FILTRE DROIT BF./PL. DR.
FILTRO LÍNEA ER./C. MR.

401 B

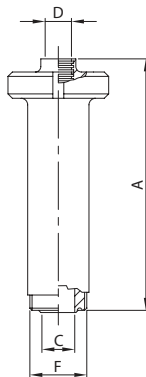

DN	A	C	D	F	gr
25	327,0	22,1	25,4	46-8	3.070
38	327,0	34,8	38,1	58-8	3.200
51	427,0	47,5	50,8	73-6	3.525
63	529,0	60,2	63,5	85-6	5.040
76	594,0	72,9	76,2	98-6	6.200
101	700,0	97,6	101,6	123-6	8.140

FILTRO 90° EL.
90° FILTER PE.
FILTRE 90° BL.
FILTRO 90° EL.

410 L

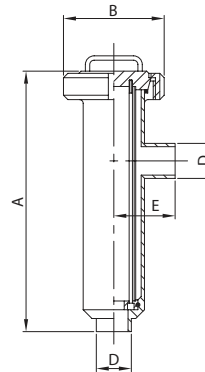

DN	A	B	D	E	gr
25	307,0	112,0	25,4	70,0	3.100
38	307,0	112,0	38,1	70,0	3.100
51	407,0	112,0	50,8	72,0	3.400
63	503,0	127,0	63,5	85,0	4.800
76	561,0	148,0	76,2	96,0	5.900
101	662,0	148,0	101,6	117,0	7.200

FILTRO 90° EF./EL.
90° FILTER ME./PE.
FILTRE 90° BF./BL.
FILTRO 90° ER./EL.

411 B

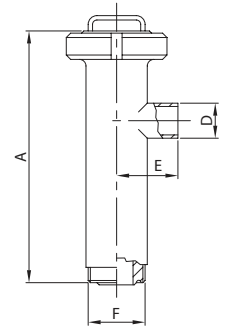

DN	A	D	E	F	gr
25	306,0	25,4	70,0	46-8	3.200
38	306,0	38,1	70,0	58-8	3.250
51	405,0	50,8	72,0	73-6	3.630
63	503,0	63,5	85,0	85-6	5.090
76	561,0	76,2	96,0	98-6	6.260
101	652,0	101,6	117,0	123-6	7.730

FILTRO 90° EF./EF.
90° FILTER ME./ME.
FILTRE 90° BF./BF.
FILTRO 90° ER./ER.

412 B

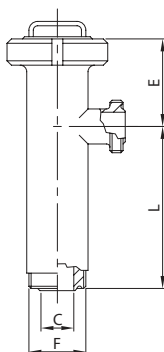

DN	C	E	F	L	gr
25	22,1	99,0	46-8	207,0	3.300
38	34,8	99,0	58-8	207,0	3.400
51	47,5	115,0	73-6	290,0	3.870
63	60,2	117,0	85-6	386,0	5.380
76	72,9	131,0	98-6	430,0	6.630
101	97,6	120,0	123-6	532,0	8.600

RIVESTIMENTO MESH
MESH COVERING
MESH GRILLE
REVESTIMIENTO MESH

400 612



DN	MESH
25/40	100/200 300 400 500
51/52	100/200 300 400 500
63/70	100/200 300 400 500
76/85	100/200 300 400 500
101	100/200 300 400 500

CARTUCCIA FILTRO LINEA
LINE FILTER CARTRIDGE
TAMIS FILTRE DROIT
CARTUCHO FILTRO LÍNEA

400 410

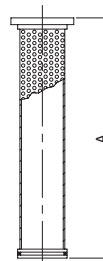

DN	A
25/40	271,0
51/52	371,0
63/70	466,0
76/85	516,0
101	621,0

CARTUCCIA FILTRO 90°
90° FILTER CARTRIDGE
TAMIS FILTRE 90°
CARTUCHO FILTRO 90°

410 410

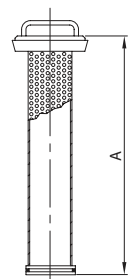

DN	A
25/40	278,0
51/52	378,0
63/70	473,0
76/85	527,0
101	636,0

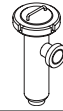

**SPECOLA EL.
SIGHT GLASS PE.
REGARD BL.
MIRILLA EL.**

450 L

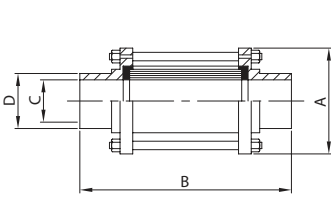

**SPECOLA EF/EF.
SIGHT GLASS ME./ME.
REGARD BF/BF.
MIRILLA ER./ER.**

452 B

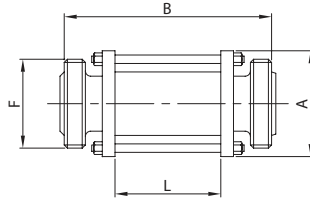

**SPECOLA BL. G./EF. MT.
SIGHT GLASS L. N./ME. ED.
REGARD PL. E./BF. DN.
MIRILLA C. T./ER. MD.**

454 B

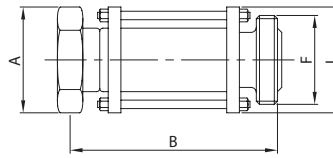

**SPECOLA EL. + V. F. EL.
SIGHT GLASS PE. + B. V. PE.
REGARD BL. + V. P. BL.
MIRILLA EL. + V. M. EL.**

460 L

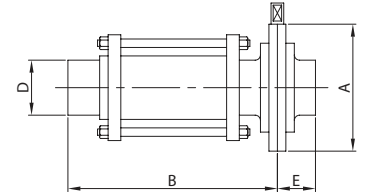

DN	A	B	C	D	gr
25	55,0	147,0	22,4	25,4	400
38	70,0	153,0	35,1	38,1	620
51	85,0	153,0	47,8	50,8	860
63	95,0	163,0	60,5	63,5	950
76	105,0	173,0	72,9	76,2	1.100
101	140,0	173,0	97,6	101,6	2.760

DN	A	B	F	L	gr
25	55,0	155,6	46-8	83,0	550
38	70,0	155,6	58-8	83,0	940
51	85,0	155,6	73-6	83,0	1.270
63	95,0	155,6	85-6	83,0	1.400
76	105,0	155,6	98-6	83,0	1.710
101	140,0	155,6	123-6	83,0	3.760

DN	A	B	F	L	gr
25	51,0	163,3	46-8	55,0	630
38	65,0	166,3	58-8	70,0	1.080
51	80,0	166,3	73-6	85,0	1.480
63	92,0	168,3	85-6	95,0	1.830
76	104,0	173,3	98-6	105,0	2.120
101	130,0	173,3	123-6	140,0	4.170

DN	A	B	D	E	gr
25	79,0	153,0	25,4	34,0	760
38	85,0	156,0	38,1	38,0	1.020
51	105,0	156,0	50,8	40,0	1.500
63	112,0	162,0	63,5	40,0	1.680
76	125,0	167,0	76,2	41,0	1.980
101	157,0	167,0	101,6	44,0	4.180

**SPECOLA EF. + V. F. EF.
SIGHT GLASS ME. + B. V. ME.
REGARD BF. + V. P. BF.
MIRILLA ER. + V. M. ER.**

462 B

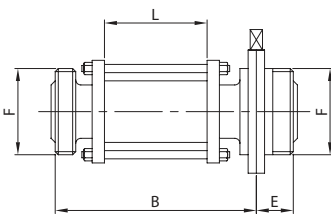

**SPECOLA PIANA ES.
SIGHT GLASS WE.
INDIC. DE CIRC. PLAT BS.
MIRILLA PLANA ES.**

441 B

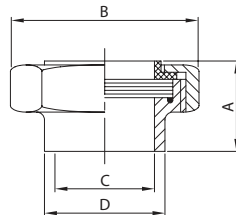

**SPECOLA PIANA EM.
SIGHT GLASS EE.
INDIC. DE CIRC. PLAT BD.
MIRILLA PLANA EM.**

442 B

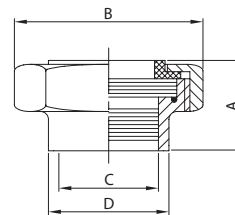

DN	B	E	F	L	gr
25	157,3	34,0	46-8	83,0	1.030
38	157,3	38,0	58-8	83,0	1.570
51	157,3	40,0	73-6	83,0	2.220
63	158,3	40,0	85-6	83,0	2.250
76	158,3	41,0	98-6	83,0	3.090
101	158,3	44,0	123-6	83,0	5.880

DN	A	B	C	D	gr
25	28,0	51,0	22,1	25,4	290
38	32,0	65,0	34,8	38,1	410
51	36,0	80,0	47,5	50,8	540
63	40,0	92,0	60,2	63,5	890
76	41,0	104,0	72,9	76,2	970
101	42,0	130,0	97,6	101,6	1.200

DN	A	B	C	D	gr
25	28,0	51,0	25,4	32,5	290
38	32,0	65,0	38,1	45,2	410
51	36,0	80,0	50,8	58,0	540
63	40,0	92,0	63,5	70,6	890
76	41,0	104,0	76,2	83,3	970
101	42,0	130,0	101,6	109,0	1.200



FILTRO LINEA EL.
LINE FILTER PE.
FILTRE DROIT BL.
FILTRO LÍNEA EL.

400 L

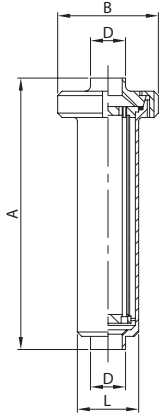

DN	A	B	D	L	gr
25	320,0	112,0	25,4	70,0	3.000
38	320,0	112,0	38,1	70,0	3.000
51	420,0	112,0	50,8	70,0	3.300
63	516,0	127,0	63,5	85,0	4.650
76	574,0	148,0	76,2	102,0	5.700
101	700,0	148,0	101,6	129,0	7.000

FILTRO LINEA EF./BL. MR.
LINE FILTER ME./L. EG.
FILTRE DROIT BF./PL. DR.
FILTRO LÍNEA ER./C. MR.

401 I

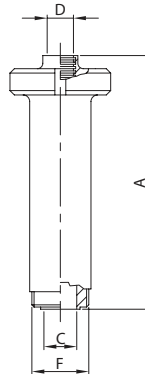

DN	A	C	D	F	gr
25	327,0	22,1	25,4	37-8	3.050
38	327,0	34,8	38,1	50-8	3.100
51	427,0	47,5	50,8	64-8	3.420
63	529,0	60,2	63,5	77-8	4.845
76	594,0	72,9	76,2	91-8	5.960
101	700,0	97,6	101,6	118-8	7.520

FILTRO 90° EL.
90° FILTER PE.
FILTRE 90° BL.
FILTRO 90° EL.

410 L

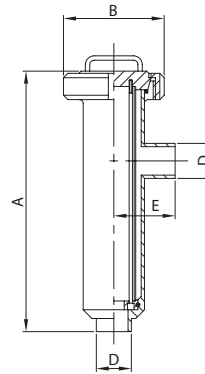

DN	A	B	D	E	gr
25	307,0	112,0	25,4	70,0	3.100
38	307,0	112,0	38,1	70,0	3.100
51	407,0	112,0	50,8	72,0	3.400
63	503,0	127,0	63,5	85,0	4.800
76	561,0	148,0	76,2	96,0	5.900
101	662,0	148,0	101,6	117,0	7.200

FILTRO 90° EF./EL.
90° FILTER ME./PE.
FILTRE 90° BF./BL.
FILTRO 90° ER./EL.

411 I

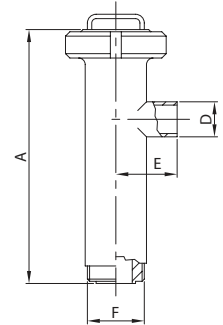

DN	A	D	E	F	gr
25	306,0	25,4	70,0	37-8	3.150
38	306,0	38,1	70,0	50-8	3.200
51	405,0	50,8	72,0	64-8	3.520
63	503,0	63,5	85,0	77-8	4.990
76	561,0	76,2	96,0	91-8	6.160
101	652,0	101,6	117,0	118-8	7.720

FILTRO 90° EF./EF.
90° FILTER ME./ME.
FILTRE 90° BF./BF.
FILTRO 90° ER./ER.

412 I

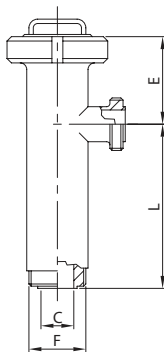

DN	C	E	F	L	gr
25	22,1	99,0	37-8	207,0	3.200
38	34,8	99,0	50-8	207,0	3.300
51	47,5	115,0	64-8	290,0	3.620
63	60,2	117,0	77-8	386,0	5.190
76	72,9	131,0	91-8	430,0	6.420
101	97,6	120,0	118-8	532,0	8.240

RIVESTIMENTO MESH
MESH COVERING
MESH GRILLE
REVESTIMIENTO MESH

400 612



DN	MESH
25/40	100/200 300 400 500
51/52	100/200 300 400 500
63/70	100/200 300 400 500
76/85	100/200 300 400 500
101	100/200 300 400 500

CARTUCCIA FILTRO LINEA
LINE FILTER CARTRIDGE
TAMIS FILTRE DROIT
CARTUCHO FILTRO LÍNEA

400 410

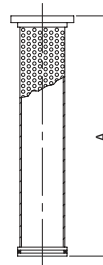

DN	A
25/40	271,0
51/52	371,0
63/70	466,0
76/85	516,0
101	621,0

CARTUCCIA FILTRO 90°
90° FILTER CARTRIDGE
TAMIS FILTRE 90°
CARTUCHO FILTRO 90°

410 410

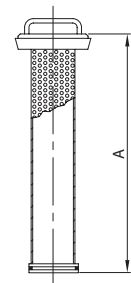

DN	A
25/40	278,0
51/52	378,0
63/70	473,0
76/85	527,0
101	636,0

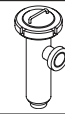

**SPECOLA EL.
SIGHT GLASS PE.
REGARD BL.
MIRILLA EL.**

**SPECOLA EF/EF.
SIGHT GLASS ME./ME.
REGARD BF/BF.
MIRILLA ER./ER.**

**SPECOLA BL. G./EF. MT.
SIGHT GLASS L. N./ME. ED.
REGARD PL. E./BF. DN.
MIRILLA C. T./ER. MD.**

**SPECOLA EL. + V. F. EL.
SIGHT GLASS PE. + B. V. PE.
REGARD BL. + V. P. BL.
MIRILLA EL. + V. M. EL.**

450 L

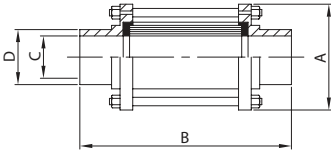

452 I

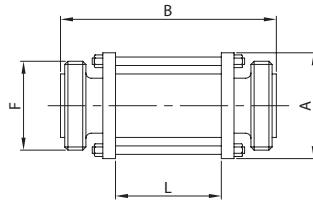

454 I

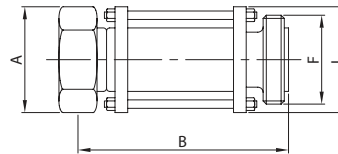

460 L

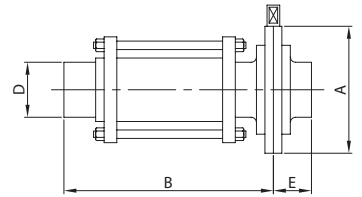

DN	A	B	C	D	gr
25	55,0	147,0	22,4	25,4	400
38	70,0	153,0	35,1	38,1	620
51	85,0	153,0	47,8	50,8	860
63	95,0	163,0	60,5	63,5	950
76	105,0	173,0	72,9	76,2	1.100
101	140,0	173,0	97,6	101,6	2.760

DN	A	B	F	L	gr
25	55,0	165,0	37-8	83,0	550
38	70,0	165,0	50-8	83,0	940
51	85,0	165,0	64-8	83,0	1.270
63	95,0	165,0	77-8	83,0	1.400
76	105,0	165,0	91-8	83,0	1.710
101	140,0	165,0	118-8	83,0	3.760

DN	A	B	F	L	gr
25	46,0	169,0	37-8	55,0	660
38	60,0	169,0	50-8	70,0	1.110
51	75,0	169,0	64-8	85,0	1.560
63	90,0	169,0	77-8	95,0	1.920
76	105,0	169,0	91-8	105,0	2.300
101	134,0	169,0	118-8	140,0	4.730

DN	A	B	D	E	gr
25	79,0	153,0	25,4	34,0	760
38	85,0	156,0	38,1	38,0	1.020
51	105,0	156,0	50,8	40,0	1.500
63	112,0	162,0	63,5	40,0	1.680
76	125,0	167,0	76,2	41,0	1.980
101	157,0	167,0	101,6	44,0	4.180

**SPECOLA EF. + V. F. EF.
SIGHT GLASS ME. + B. V. ME.
REGARD BF. + V. P. BF.
MIRILLA ER. + V. M. ER.**

**SPECOLA PIANA ES.
SIGHT GLASS WE.
INDIC. DE CIRC. PLAT BS.
MIRILLA PLANA ES.**

**SPECOLA PIANA EM.
SIGHT GLASS EE.
INDIC. DE CIRC. PLAT BD.
MIRILLA PLANA EM.**

462 I

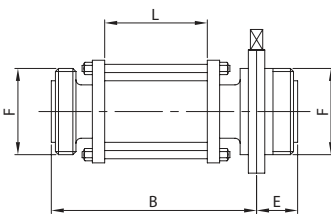

441 I

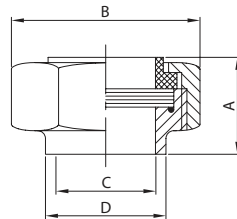

442 I

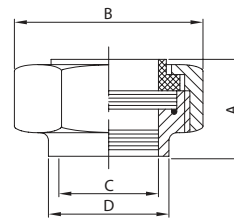

DN	B	E	F	L	gr
25	162,0	34,0	37-8	83,0	1.010
38	162,0	38,0	50-8	83,0	1.520
51	162,0	40,0	64-8	83,0	2.090
63	163,0	40,0	77-8	83,0	2.310
76	163,0	41,0	91-8	83,0	2.820
101	163,0	44,0	118-8	83,0	5.480

DN	A	B	C	D	gr
25	28,0	46,0	22,1	25,4	300
38	32,0	60,0	34,8	38,1	430
51	36,0	75,0	47,5	50,8	600
63	40,0	90,0	60,2	63,5	940
76	41,0	105,0	72,9	76,2	1.120
101	42,0	134,0	97,6	101,6	1.670

DN	A	B	C	D	gr
25	28,0	46,0	25,4	29,0	200
38	32,0	60,0	38,1	42,5	430
51	36,0	75,0	50,8	56,0	600
63	40,0	90,0	63,5	69,7	940
76	41,0	105,0	76,2	82,3	1.120
101	42,0	134,0	101,6	108,5	1.670